

Recessed 24



Designed for various applications, the extruded anodized aluminum profile is durable and corrosion-resistant. The profile cover is high resistance polycarbonate with milky or clear finish.



Specifications

Material	Aluminum
Body Finish	Anodized
Mounting Type	Recessed
Cover	Milky / Clear
Dimensions (LxWxH)	2000 x 61 x 14mm
PCB Width Limit	20mm
Accessories	4 x Endcap

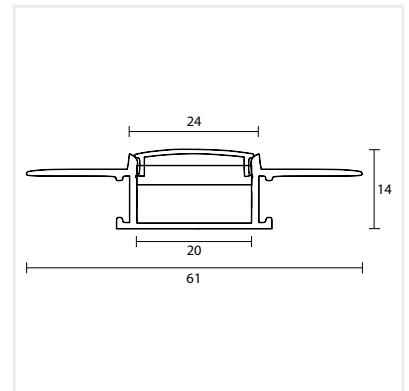

Cover Type	Product Code
Milky	AP703M
Clear	AP703C