

Canna / R Duo

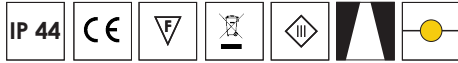

A recessed fixture with double spots, featuring a deep aspect into the ceiling to create an illusion on the light source. Designed for indoor spaces in a die-cast aluminum housing. Canna is designed to deliver a high level of glare-free visual comfort.



Luminaire

Product type: Downlight
 Material: Diecast Aluminum / PMMA Cover
 Finish: White, Grey, Black, Custom

Installation

Environment: Indoor
 Ceiling Type: Gypsum, wood
 Mounting: Recessed
 Dimensions (L x W - H): 220mm x 110mm - 70mm
 Cutout Dimensions (φ): 2 x 85mm
 IP: 44

Light Source

Lumen output: From 2000lm to 4880lm
 Power: 18W, 24W, 32W, 36W

Optics

Light controller type: Reflector
 Light emission beam: 15°, 25°, 38°, 60°
 CRI: 80+, 90+

Electrical Equipment

Mains voltage (V): 24
 Dimming Type: On/Off, Dali, 1-10V, Phase Dimming

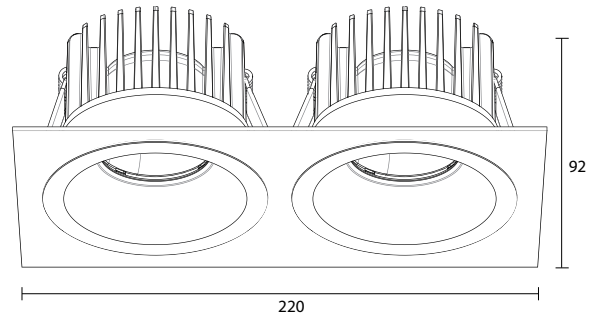
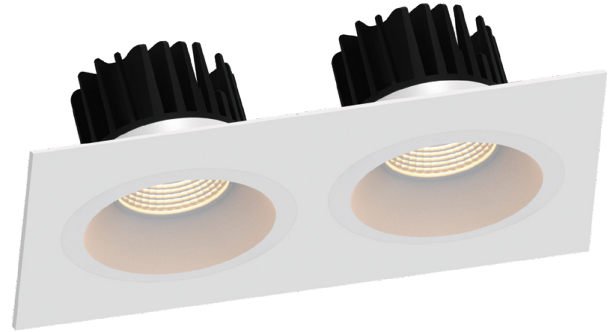

Polar Curves & LOR

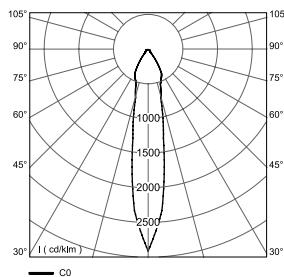

Beam Angle 15°
LOR: 75%

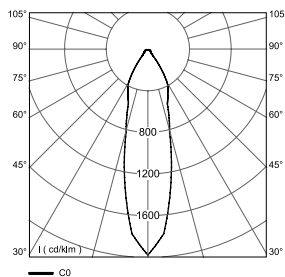

Beam Angle 25°
LOR: 79%

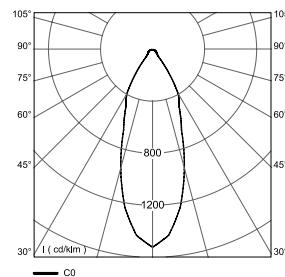

Beam Angle 38°
LOR: 80%

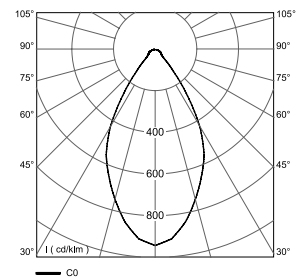

Beam Angle 60°
LOR: 81%

Canna / R Duo



Product Reference:

Designation	CCT	LED Luminous Output								Product Code*
		Power 9Wx2		Power 12Wx2		Power 16Wx2		Power 18Wx2		
		CRI								
		80	90	80	90	80	90	80	90	
CR09D	2700 K	2400lm	2000lm	3260lm	2720lm	3920lm	2730lm	4360lm	3630lm	CR09D.A27.B.CDE
CR09D	3000 K	2500lm	2080lm	3390lm	2830lm	4080lm	3400lm	4540lm	3800lm	CR09D.A30.B.CDE
CR09D	4000 K	2600lm	2230lm	3520lm	3030lm	4240lm	3650lm	4720lm	4050lm	CR09D.A40.B.CDE
CR09D	5000 K	2680lm	2270lm	3640lm	3070lm	4380lm	3700lm	4880lm	4110lm	CR09D.A50.B.CDE

* Check the below table to build the code

CRI	A	CCT	-	POWER	B	BEAM ANGLE	C	DIMMING	D	FINISH	E
80+	8	2700K	27	18W	18	15°	1	On/Off	1	Black	1
90+	9	3000K	30	24W	24	25°	2	Dali	2	Grey	2
		4000K	40	32W	32	38°	3	1-10V	3	White	3
		5000K	50	36W	36	60°	4	Phase	4	Custom	4

Product Code: