

LED Panel



A variation of low glare LED panels, ideal for multifunctional areas in offices and commercial buildings. The diffuser offers complete uniformity for ambient lighting. The fixture can be ceiling mounted or recessed.



Specifications

Body Material	Aluminum
Dimensions (LxW)	295x1195mm
Thickness	9mm
Voltage	220-240V
Frequency	50-60Hz
Power	40W
CRI	80+
Beam Angle	112°

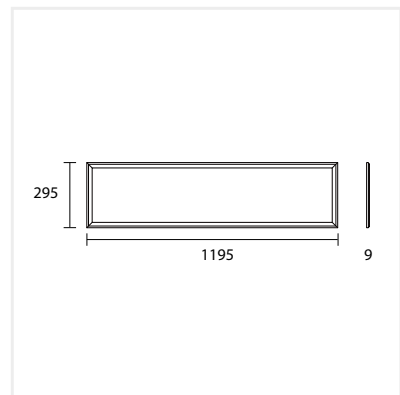

Designation	CCT	LED Luminous Output		Product Code*
		Power 40W		
		CRI 80+		
		Opal	Micro prismatic	
LP40	3000 K	3950lm	4150lm	LP40.122.312.830.138.BC
LP40	4000 K	4000lm	4200lm	LP40.122.312.840.138.BC
LP40	6000 K	4100lm	4300lm	LP40.122.312.860.138.BC

CCT	A	DIFFUSER	B	DIMMING	C
3000K	30	Opal	O	On/Off	1
4000K	40	Microprismatic	P	Dali	2
6000K	60			1-10V	3

Product Code:

